

ASSEMBLY INSTRUCTIONS

EEI-6126

V1.22.12.22

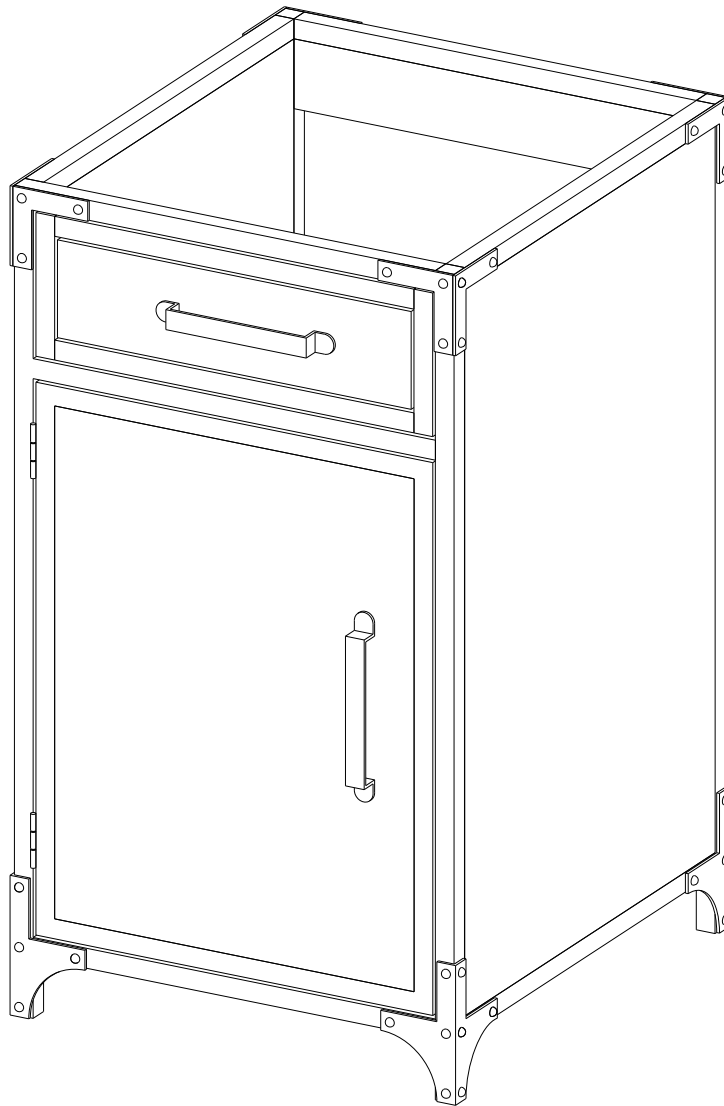

Questions? Contact us!

609.256.9000 • cs@modway.com
www.modway.com

*modway

Let's get started!

*modway



Read through all of the instructions before starting



Care instructions are listed in the last step of this manual



Approx. 60 minutes assembly time



Make sure you have all parts and components before discarding any packing materials



2 people recommended for assembly

Only use hand tools to assemble this item. Do not use power tools. Do not tighten bolts or screws completely until all hardware is lined up and inserted into the holes.

Do not over-tighten screws and bolts to avoid stripping the hardware or cracking the item.

For vanity and plumbing installation, we suggest hiring a professional contractor and plumber.

Assemble your item on a flat, carpeted area, with plenty of space to work. This will prevent damage and scratches to your floors or the item while you're assembling the product.

Keep all components and packaging out of reach of children or animals to avoid risk of choking or suffocation.

Furniture components:

1 Adjustable Shelf x1

Provided hardware:

A  Shelf Pin x4

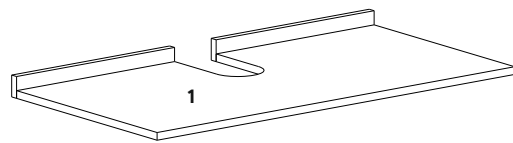

You may also need:

- + Power Drill
- + Level
- + Silicone Adhesive or Caulk
- + Drywall Anchors and Screws
- + Other Wall-Mounting Hardware

Wait!

Missing parts or hardware? Need assistance?
Contact us before returning your item. We're here to help!
609.256.9000 • cs@modway.com

Step 1

HARDWARE

A Shelf Pin **x4**

COMPONENTS

1 Adjustable Shelf **x1**

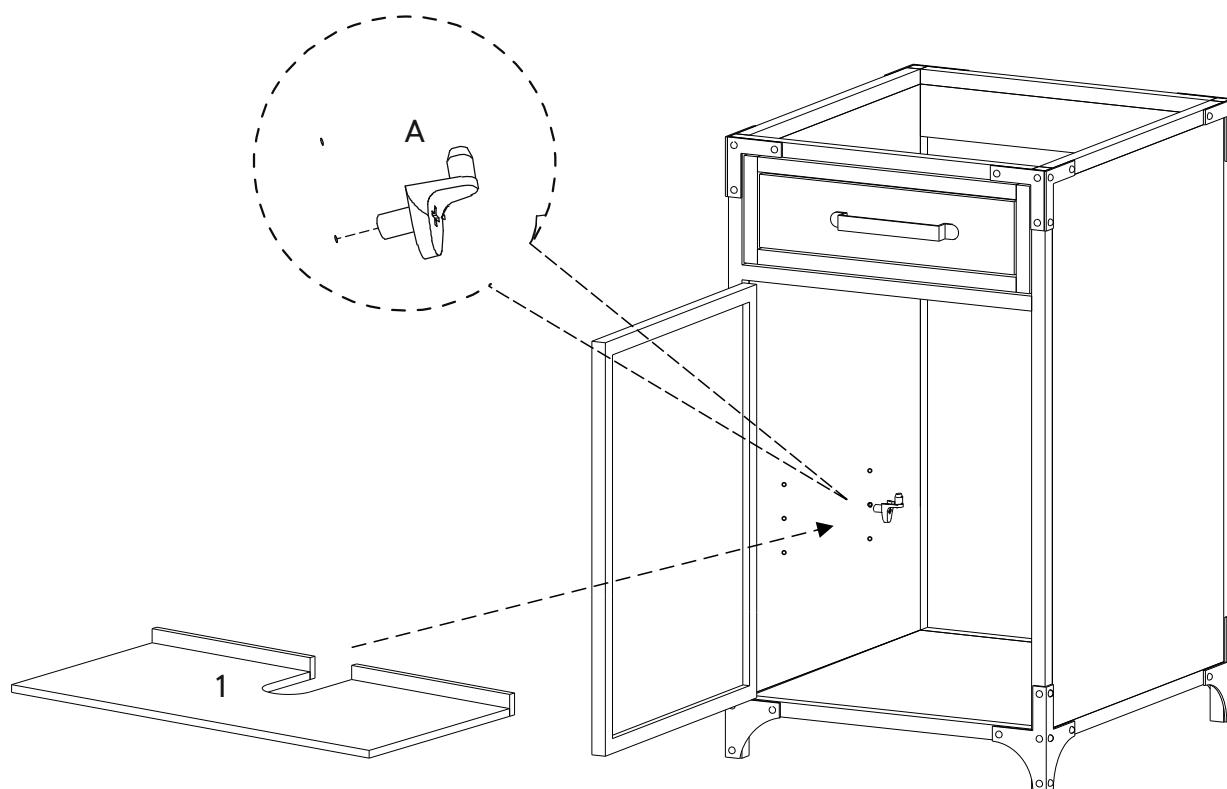

Step 2

Attachment of Furniture: This furniture may represent a danger for your security if its attachment on the wall has been done in an incorrect way. This attachment must be done by a person with great expertise who will make sure adequacy between the device of fixing and the wall. Please source the right fitting according to the wall type. For safety, it is imperative to fix your furniture to the wall.

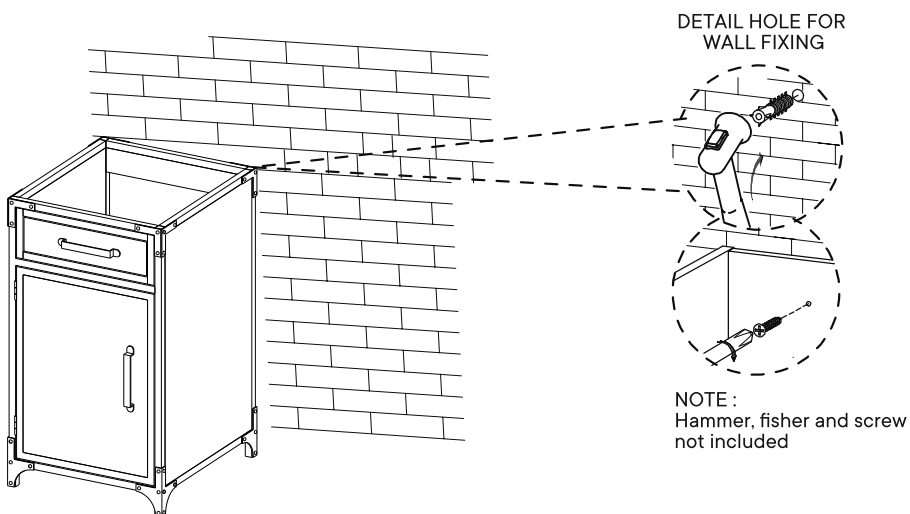

Step 3

SOLD SEPARATELY

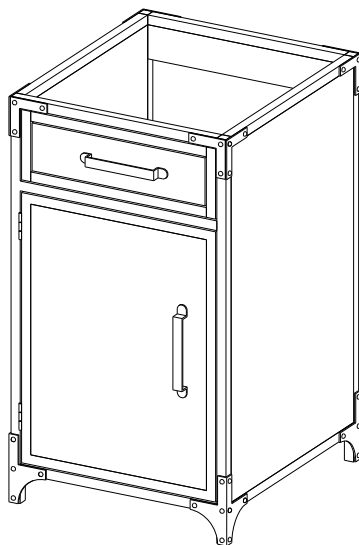
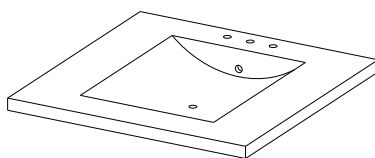

A quick note...

*modway

Your sink basin comes complete with a silver overflow ring.
If you'd like to remove this overflow ring, you can do so by hand.

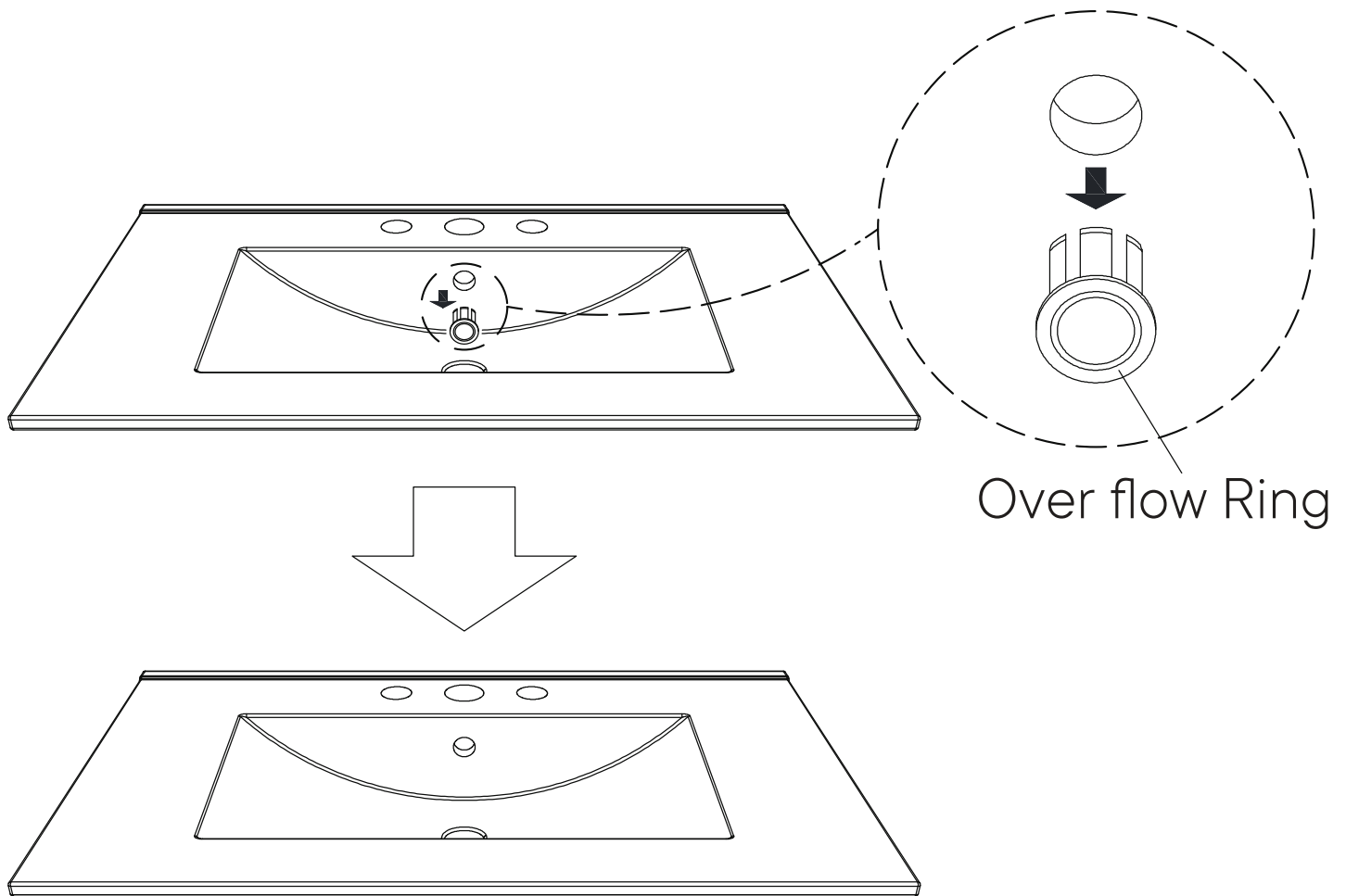

Wait!

Missing parts or hardware? Need assistance?

Contact us before returning your item. We're here to help!

609.256.9000 • cs@modway.com

Great job!

Vanity Cabinet assembly is complete.

♥ CARING FOR YOUR ITEM

Indoor use only.

Not contract grade.

Clean using a non-abrasive cloth and a mild cleaner.

Never use harsh chemicals, as they could damage the finish or integrity of the item.

CONNECT WITH US!   

Tag us **@modway_furniture** and **#modway** for a chance to be featured.

