

ASSEMBLY INSTRUCTIONS

EEI-6341

V1.01.01.24

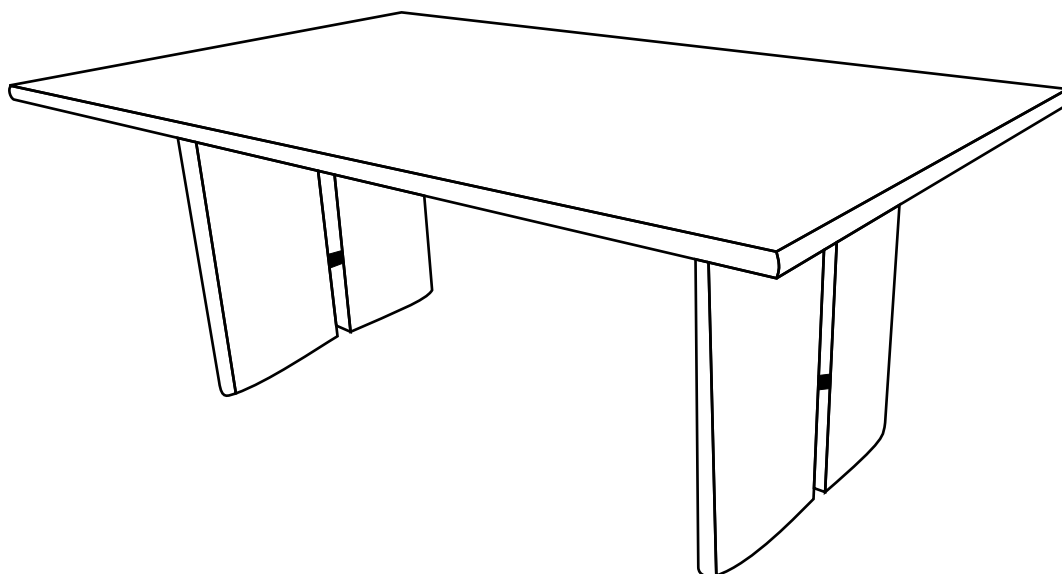

Questions? Contact us!

609.256.9000 • cs@modway.com
www.modway.com

***modway**

Let's get started!

***modway**



Read through all of the instructions before starting



Care instructions are listed in the last step of this manual



Approx. 30 minutes assembly time



Make sure you have all parts and components before discarding any packing materials



2 people recommended for assembly

Only use hand tools to assemble this item. Do not use power tools. Do not tighten bolts or screws completely until all hardware is lined up and inserted into the holes.

Do not over-tighten screws and bolts to avoid stripping the hardware or cracking the item.

Assemble your item on a flat, carpeted area, with plenty of space to work. This will prevent damage and scratches to your floors or the item while you're assembling the product.

Keep all components and packaging out of reach of children or animals to avoid risk of choking or suffocation.

Furniture components:

1	Top Panel	x1
2	Left Leg	x1
3	Right Leg	x1

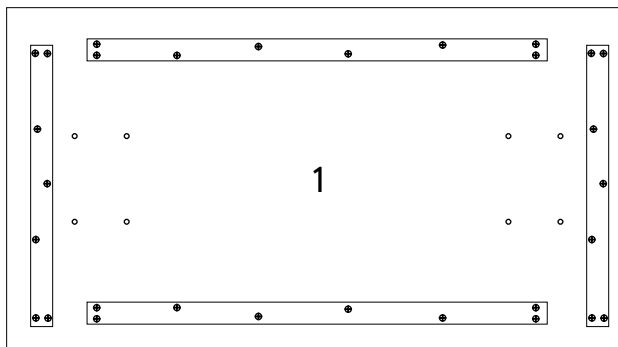

Provided hardware:

A		Allen Key M5	x1
B		JCB Bolt M8 x 20mm	x8
C		Flat Washer M8	x8
D		Top Fixing Plate 150 x 50 x 4mm	x4
E		CSK Bolt M8 x 25mm	x4
F		Leveler Ø12 x 6mm (Pre Assembled)	x4

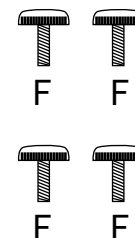
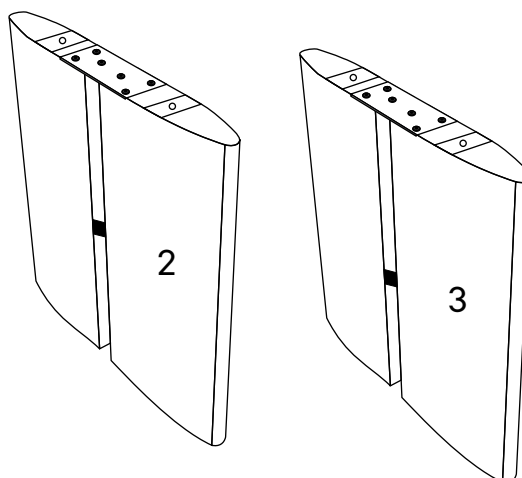
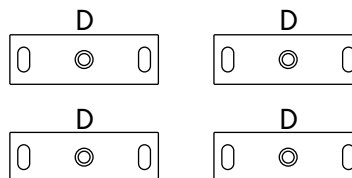

Wait!

Missing parts or hardware? Need assistance?
Contact us before returning your item. We're here to help!
609.256.9000 • cs@modway.com

Step 1

COMPONENTS

② Left Leg x1

HARDWARE

Ⓐ Allen Key M5 x1

Ⓓ Top Fixing Plate 150 x 50 x 4mm x2

Ⓔ CSK Bolt M8 x 25mm x2

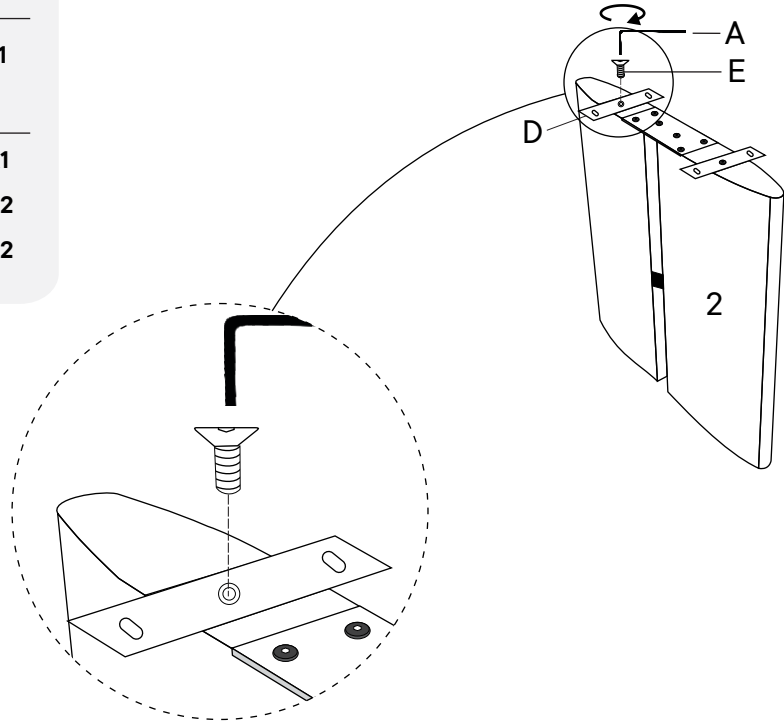

Step 2

COMPONENTS

③ Right Leg x1

HARDWARE

Ⓐ Allen Key M5 x1

Ⓓ Top Fixing Plate 150 x 50 x 4mm x2

Ⓔ CSK Bolt M8 x 25 mm x2

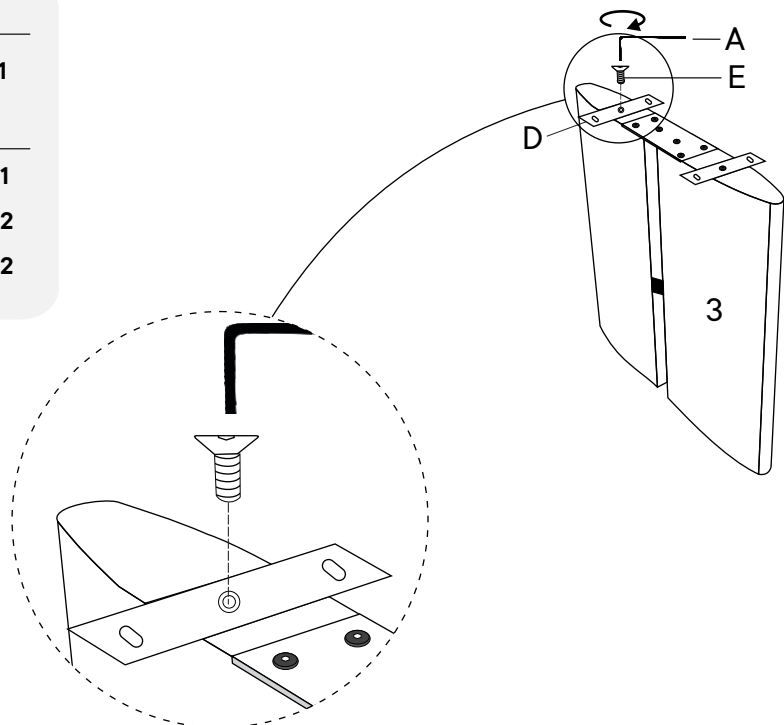

Step 3

COMPONENTS

1	Top Panel	x1
2	Left Leg	x1

HARDWARE

A	Allen Key M5	x1
B	JCB Bolt M8 x 20mm	x4
C	Flat Washer M8	x4

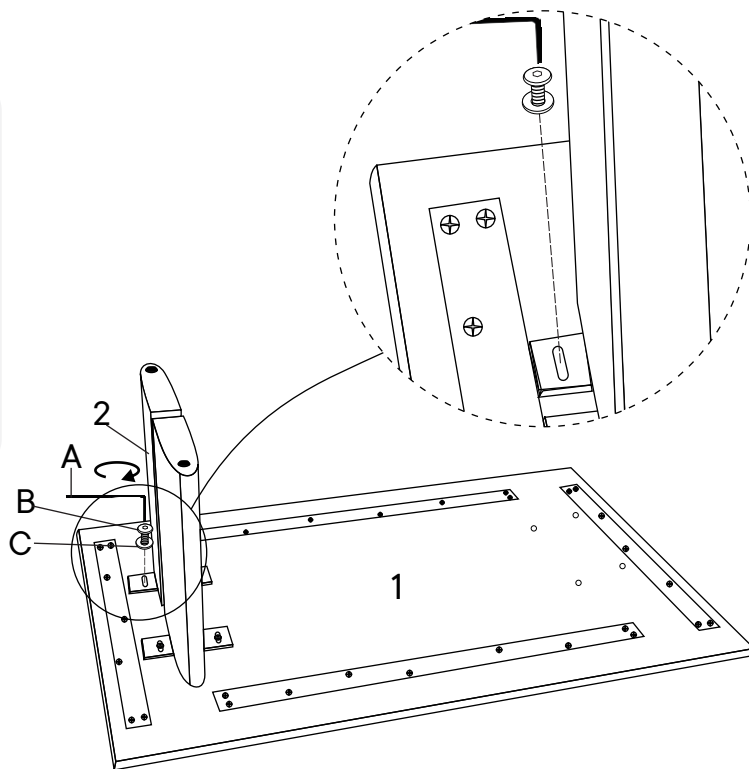

Step 4

COMPONENTS

1	Top Panel	x1
3	Right Leg	x1

HARDWARE

A	Allen Key M5	x1
B	JCB Bolt M8 x 20mm	x4
C	Flat Washer M8	x4
F	Leveler Ø12 x 6mm (Pre Assembled)	x4

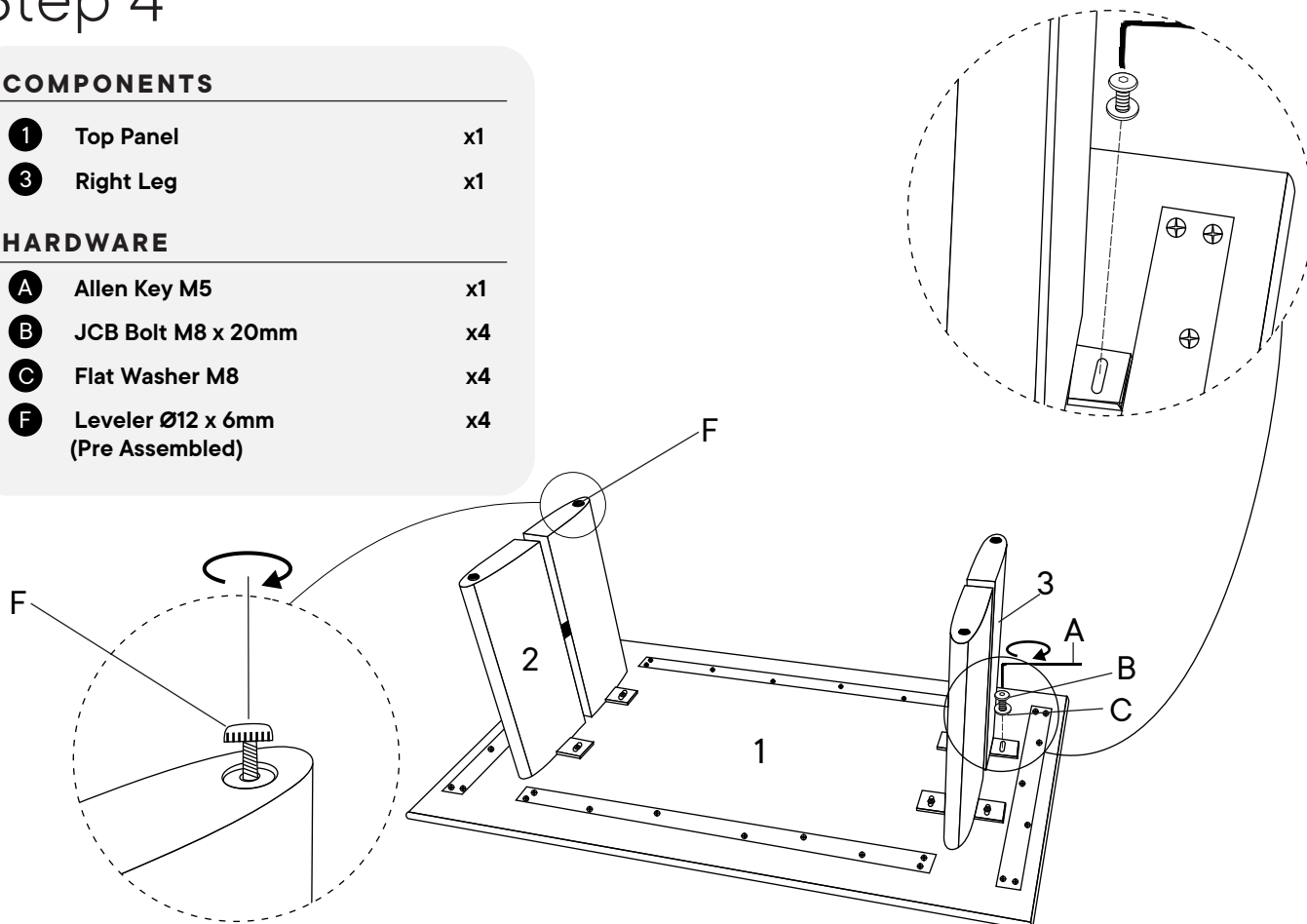

Great job!

Coffee table assembly is complete

♥ CARING FOR YOUR ITEM

Indoor use only.

Not contract grade.

Clean using a non-abrasive cloth and a mild cleaner.

Never use harsh chemicals, as they could damage the finish or integrity of the item.

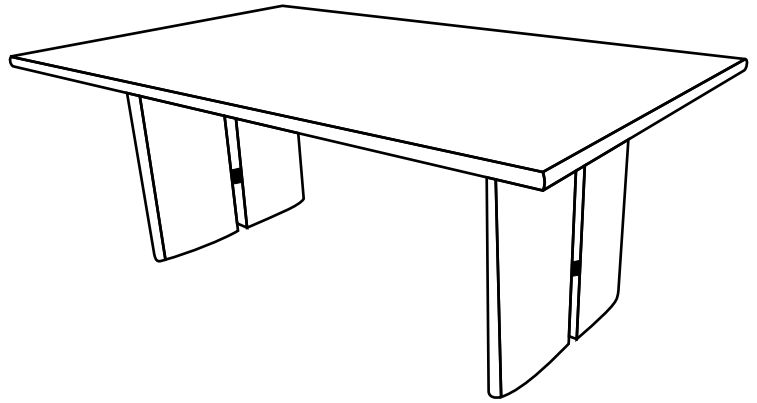

CONNECT WITH US!   

Tag us @modway_furniture and #modway for a chance to be featured.