

ASSEMBLY INSTRUCTIONS

EEI-4912/6066

V1.05.07.22

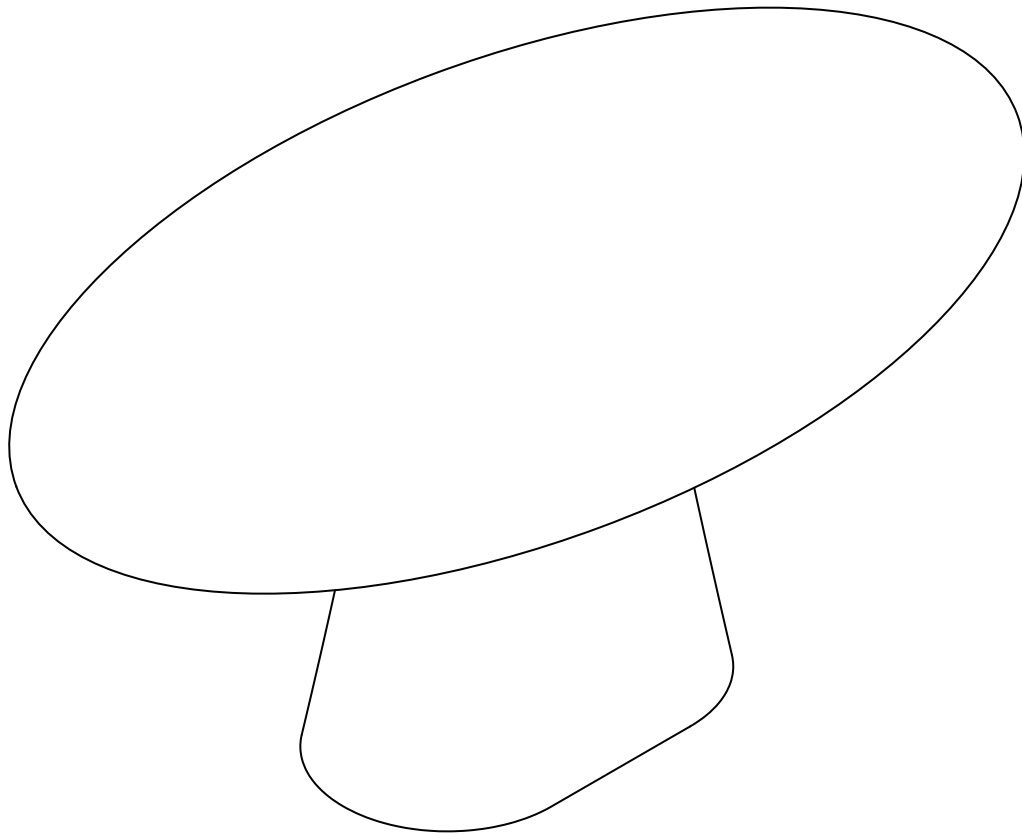

Questions? Contact us!

609.256.9000 • cs@modway.com
www.modway.com

*modway



Read through all of the instructions before starting



Care instructions are listed in the last step of this manual



Approx. 30 minutes assembly time



Make sure you have all parts and components before discarding any packing materials



2 people recommended for assembly

Only use hand tools to assemble this item. Do not use power tools. Do not tighten bolts or screws completely until all hardware is lined up and inserted into the holes.

Do not over-tighten screws and bolts to avoid stripping the hardware or cracking the item.

Assemble your item on a flat, carpeted area, with plenty of space to work. This will prevent damage and scratches to your floors or the item while you're assembling the product.



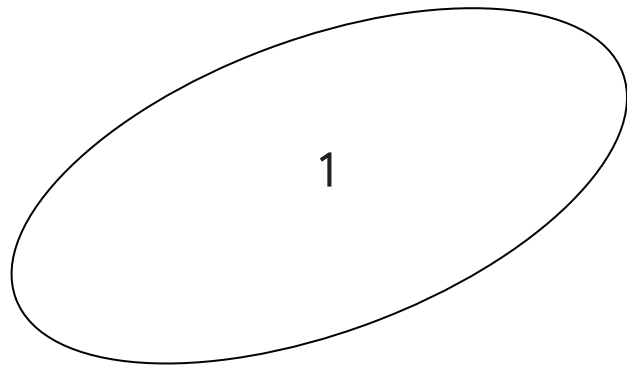

Keep all components and packaging out of reach of children or animals to avoid risk of choking or suffocation.

Furniture components:

1	Top	x1
2	Base	x1



Provided hardware:

A		Bolt M8 x 610mm	x4
B		Nut M8	x4
C		Flat Washer M8 x 30mm	x4
D		Socket wrench M8	x1

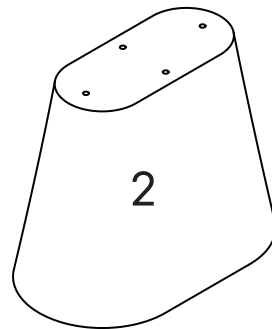

Wait!

Missing parts or hardware? Need assistance?
Contact us before returning your item. We're here to help!
609.256.9000 • cs@modway.com

Step 1

HARDWARE

A Bolt M8 x 610mm x4

COMPONENTS

1 Top x1

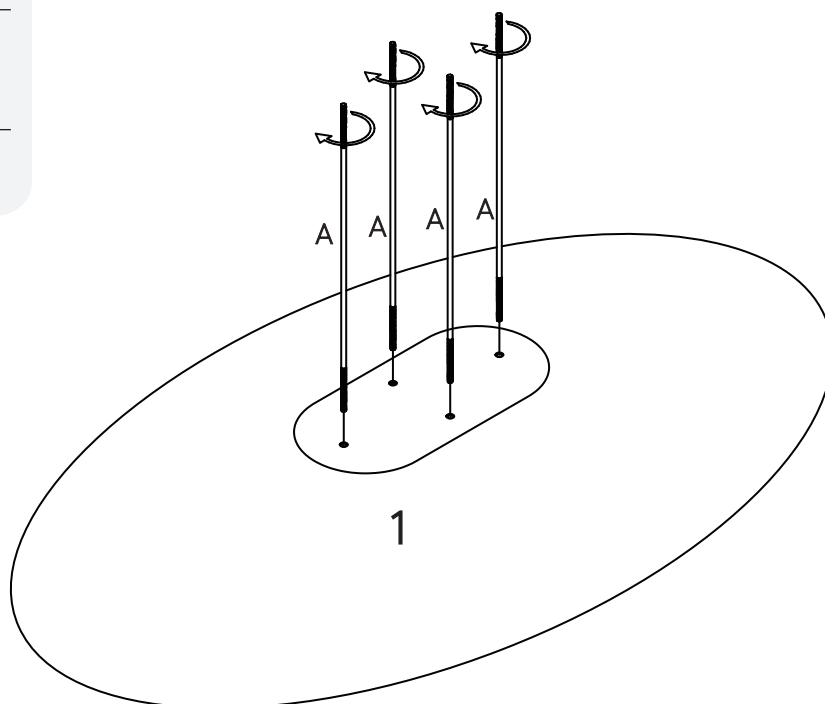

Step 2

HARDWARE

B Nut M8 x4

C Flat Washer M8 x 30mm x4

D Socket wrench M8 x1

COMPONENTS

1 Top x1

2 Base x1

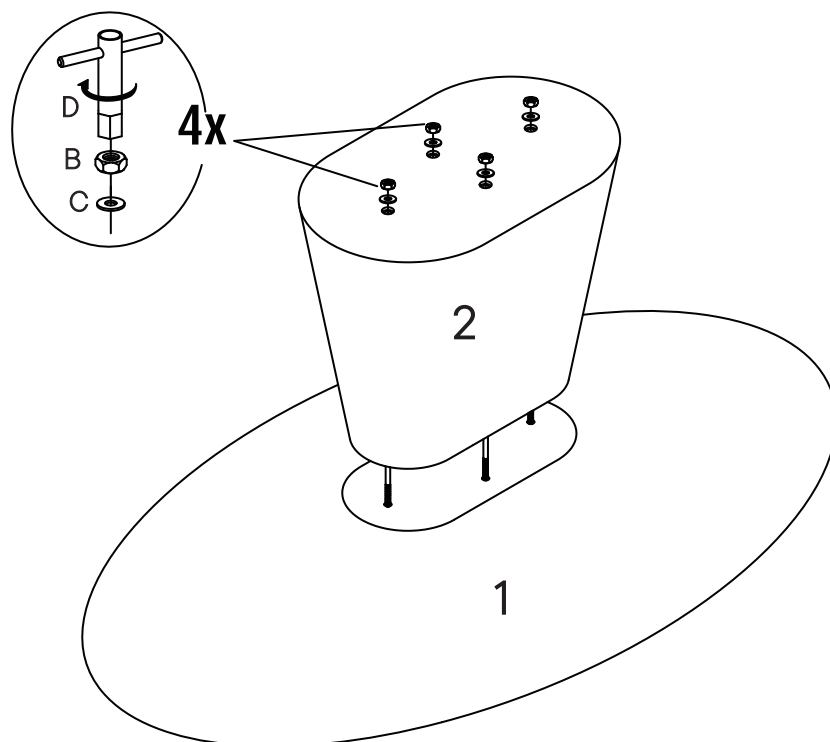

Step 3

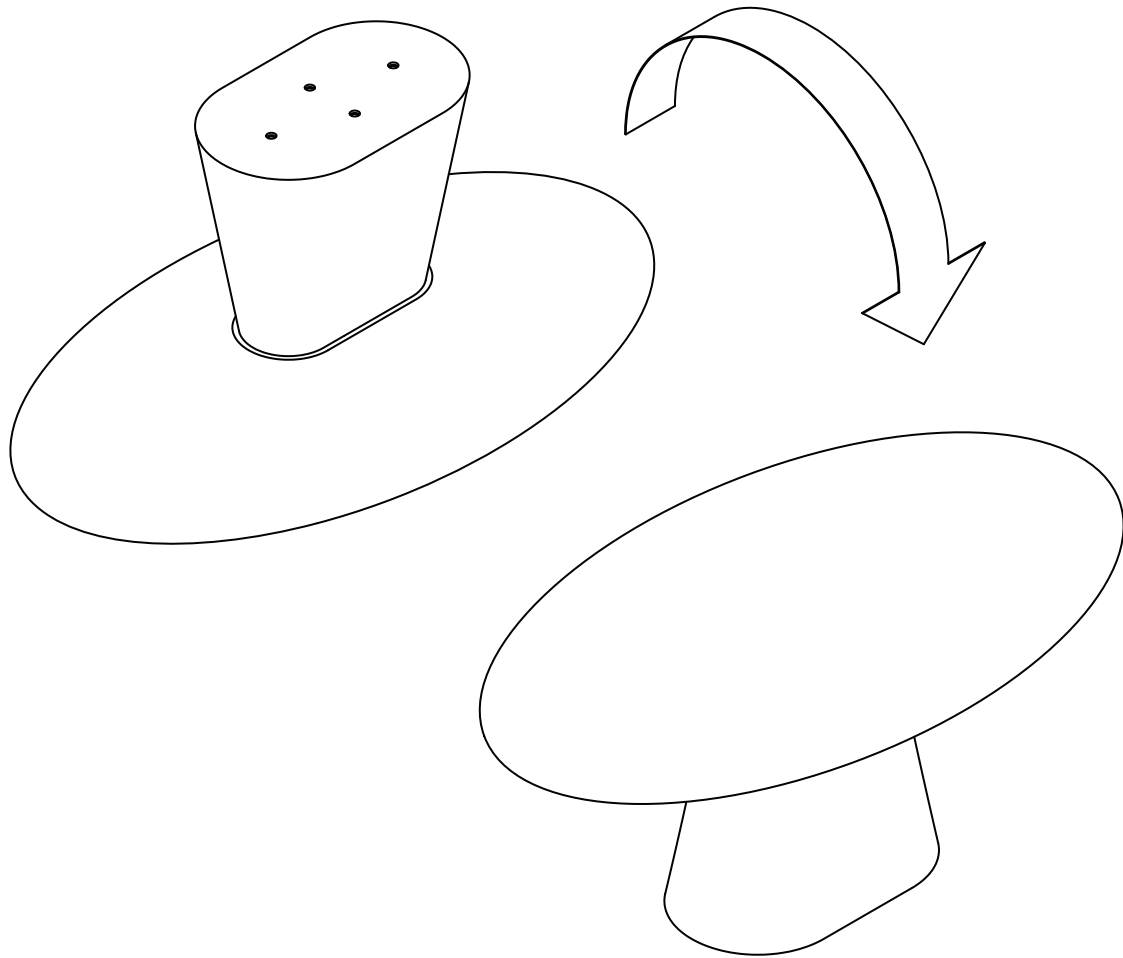

Great job!

Dining Table assembly is complete

♥ CARING FOR YOUR ITEM

Indoor use only.

Not contract grade.

Clean using a non-abrasive cloth and a mild cleaner.

Never use harsh chemicals, as they could damage the finish or integrity of the item.

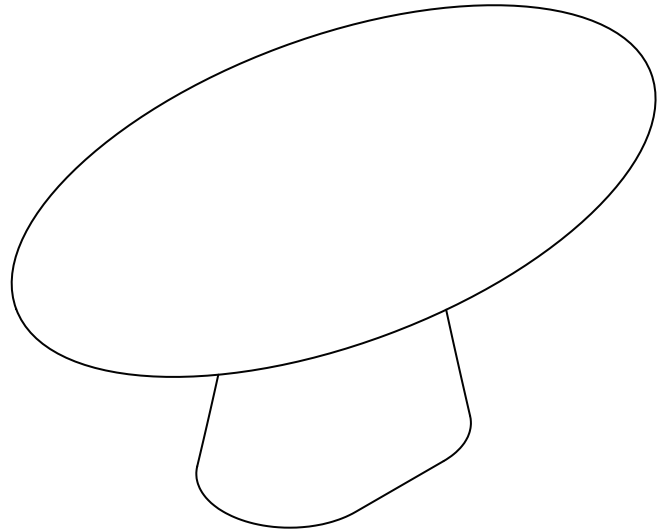

CONNECT WITH US!   

Tag us [@modway_furniture](#) and [#modway](#) for a chance to be featured.