

Thank you for purchasing the **MODWAY CHAIR** !

Before you start, here are some helpful advices :

1. We suggest you spend a short time reading through this leaflet and then follow the simple step by step instructions.
2. Owing to the size and weight of the chair, we recommend that it is assembled by two adults on a carpeted or padded area in the room that it is intended for. Approximate assembly time: 30 minutes.
3. Please do not use any tools other than those provided or recommend in these instructions.
4. Please do not throw away any of the packaging or instruction until you have checked all the components and hardware and the furniture is fully assembled. Please ensure that the packaging is disposed of in a safe and environmentally friendly way.
5. Assemble all components loosely until advised to tighten. Depending on use it may be necessary to tighten the components from time to time, so please save the tools that have been provided.
6. Please keep all pieces out of reach of children.

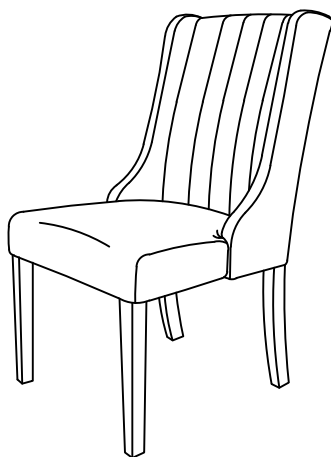

### Hardware

A.		JCBC Bolt M8 x 50mm	x 8
B.		Spring Washer	x 8
C.		Flat Washer	x 8
D.		Allen Wrench	x 1

### Components:

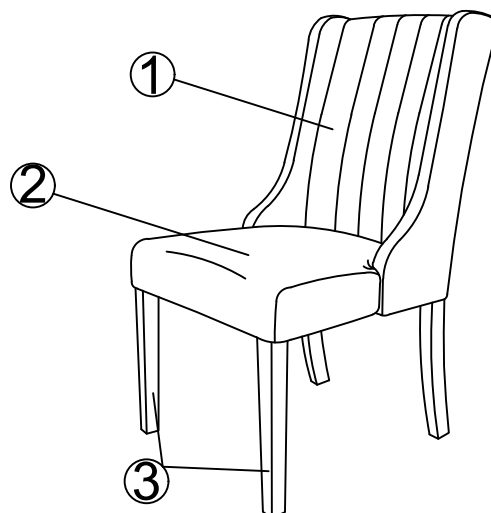





1. Chair Body X 1

2. Chair Seat X 1

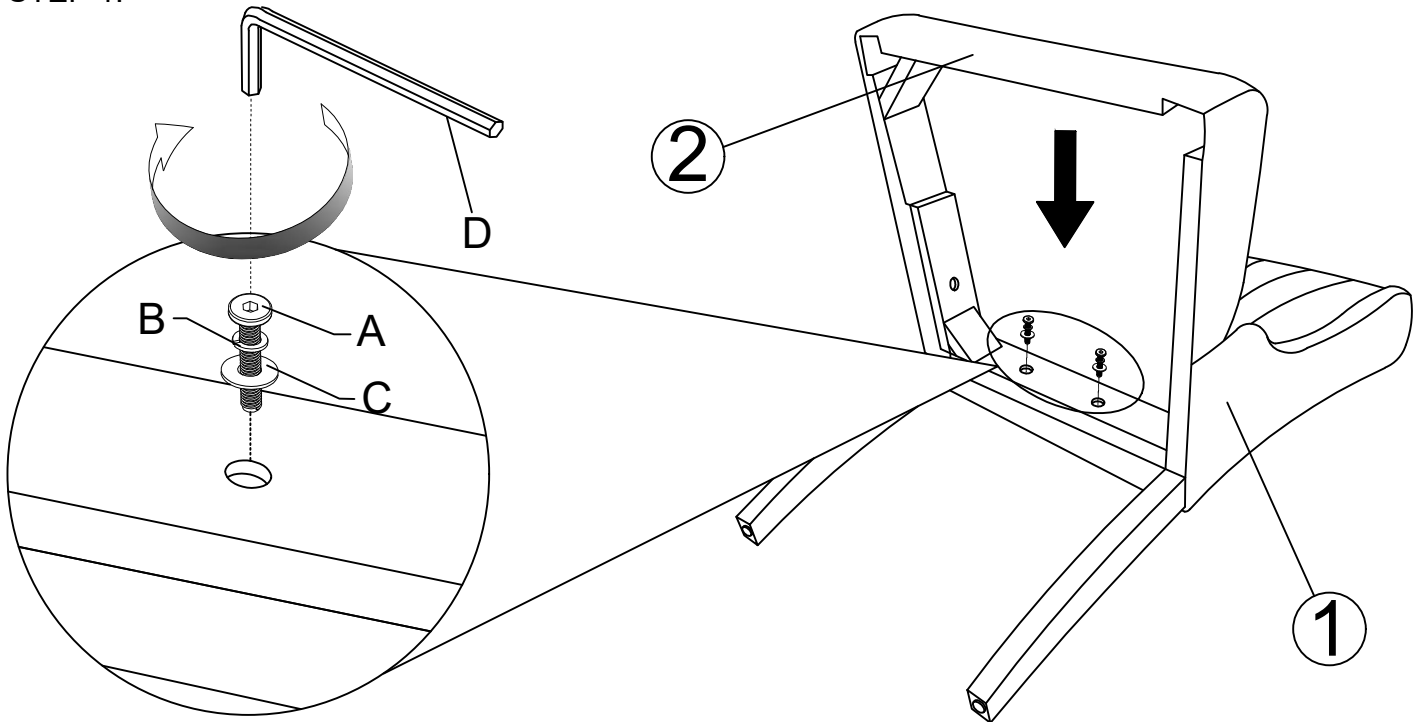
3. Front Leg X 2

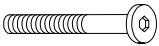
STEP 1:





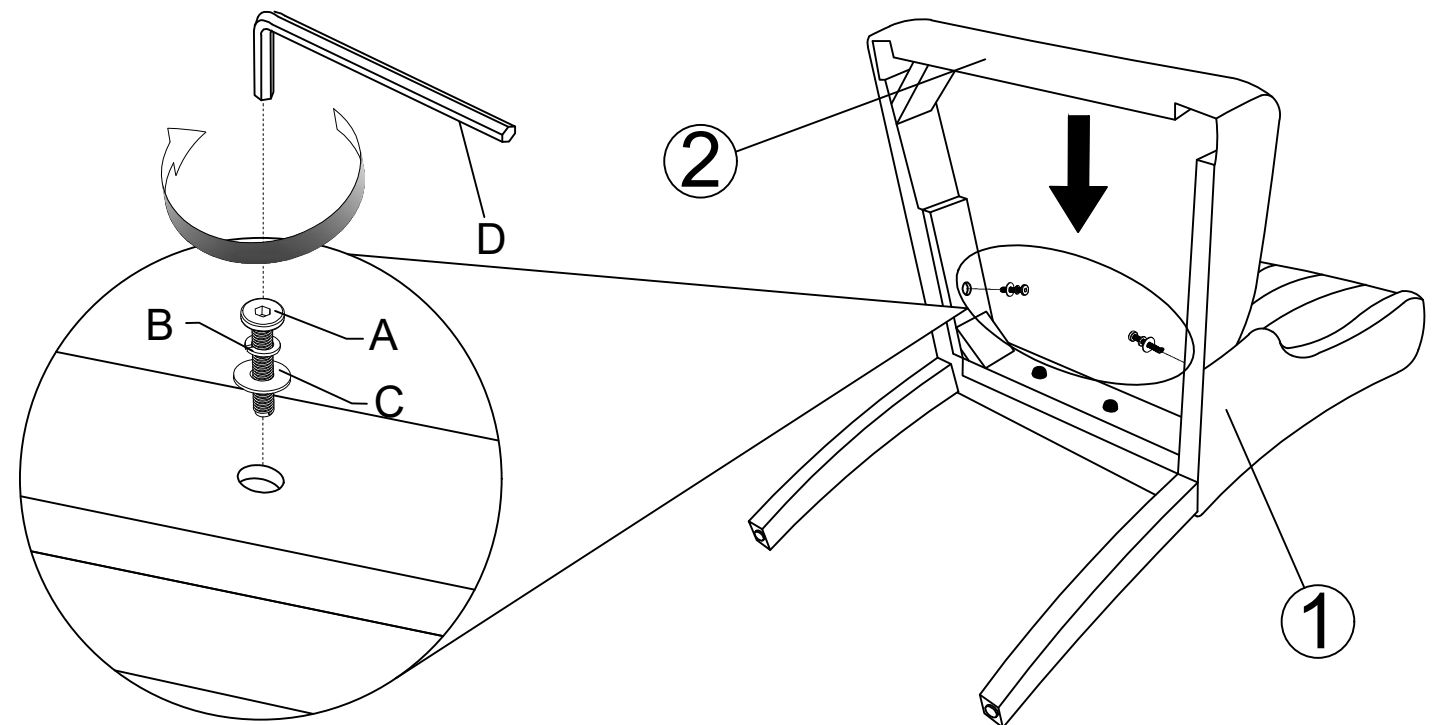

			
A x 2	B x 2	C x 2	D x 1

Hardware & Tool required

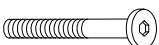
STEP 2:



			
A x 2	B x 2	C x 2	D x 1

Hardware & Tool required

STEP 3:

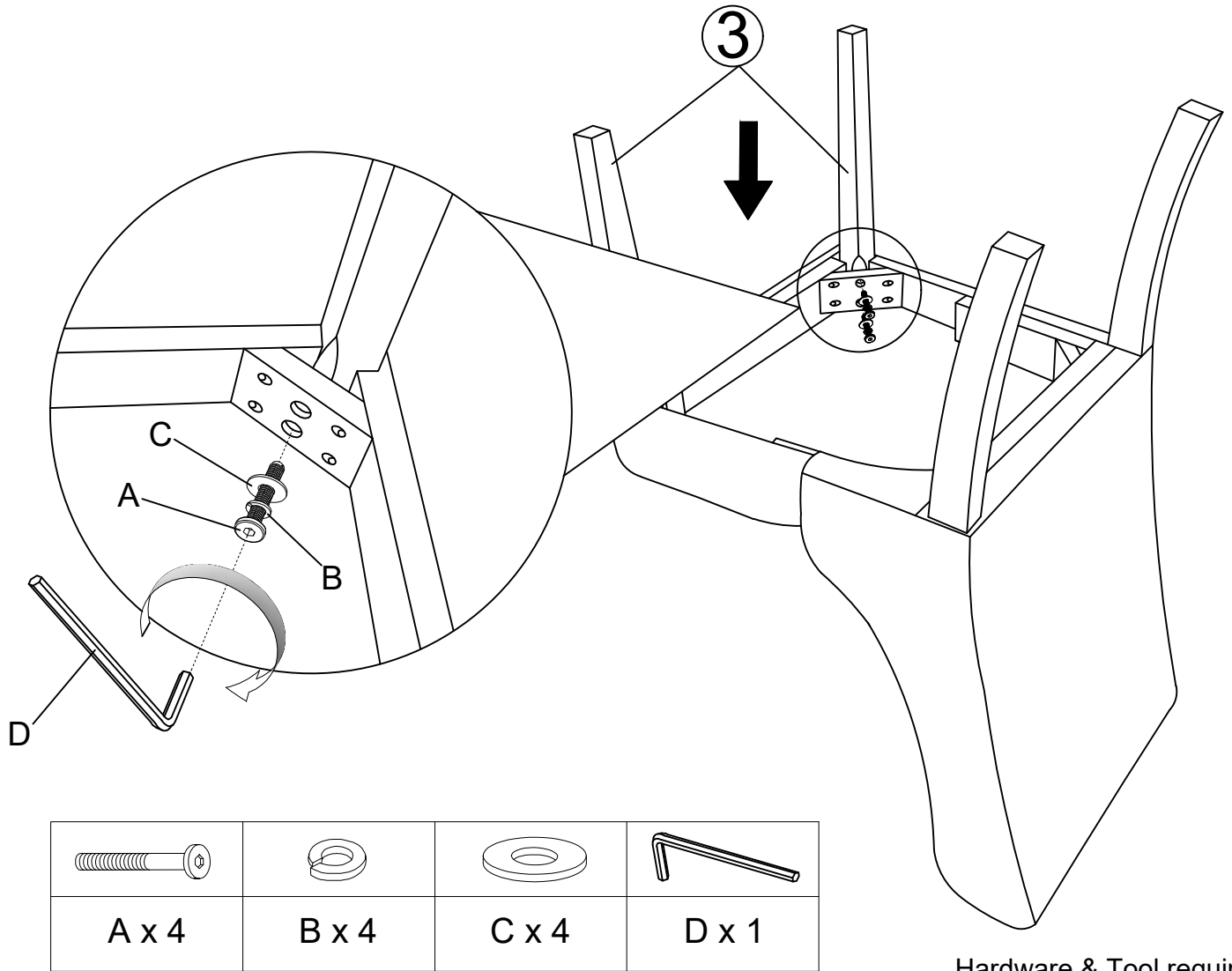

Hardware & Tool required

STEP 4:

Close the velcro tape on the bottom of **Chair Seat (2)**. Carefully turn over the assembled Chair.

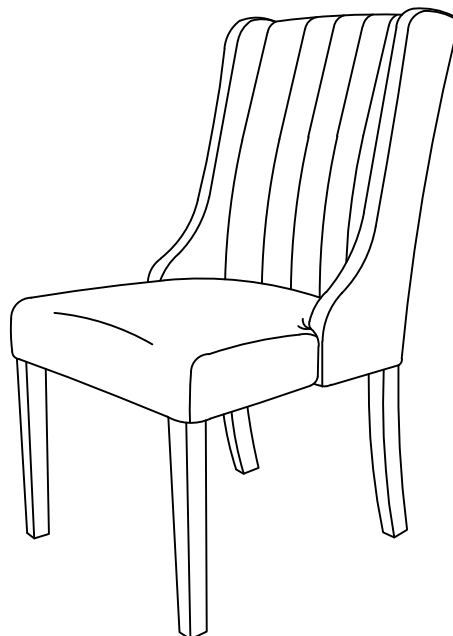

Assembly is complete. Your Chair is ready to enjoy now!