













# EEI-2302 ROUND BED



Thank you for purchasing the MODWAY ROUND BED.

Before you start, here are some helpful advice:

1. We suggest you spend a short time reading through this leaflet and then follow the simple step-by-step instructions.
2. Owing to the size and weight of the bed, we recommend that it is assembled by two adults, on a carpeted or padded area, in the room that it is intended for. Approximate assembly time: 35 minutes.
3. Please do not use any tools other than those provided or recommended in these instructions.
4. Please do not throw away any of the packaging or the instruction until you have checked all the components and hardware and the furniture is fully assembled. Please ensure that the packaging is disposed of in a safe and environmentally friendly way.
5. Assemble all components loosely until advised to tighten. Depending on use, it may be necessary to tighten the components from time to time, so please save the tools that have been provided.
6. Please keep all fitting out of reach of children.

<p><b>Option 1</b></p> 	<p><b>Hardware:</b></p> <p>A.  Bolt M8x80mm x 6</p> <p>B.  Flat Washer M8*16mm x 12</p> <p>C.  Nut x 6</p> <p>D.  Cover x 6</p> <p>E.  Wrench x 1</p> <p>F.  Allen Wrench M6 x 1</p> <p>G.  Allen Wrench M8 x 1</p> <p>H.  Support Foot x 8</p> <p>I.  Rope 4000mm x 1</p>
<p><b>Option 2</b></p> <p>with rope</p> 	
<p><b>Option 3</b></p> <p>Separate the foot</p> 	

**Component:**

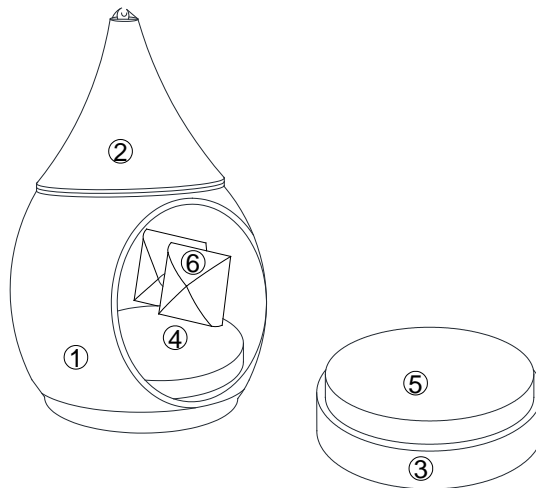

- 1 Bed Body x1      2 Bed Top x 1      3 Bed Foot x 1      4 Bed Cushion x 1
- 5 Ottoman Cushion x1      6 Pillow x 5

# EEI-2302 ROUND BED

## STEP 1:

Take out the parts from the box carton as shown.

Please put all parts on a carpeted or padded surface.

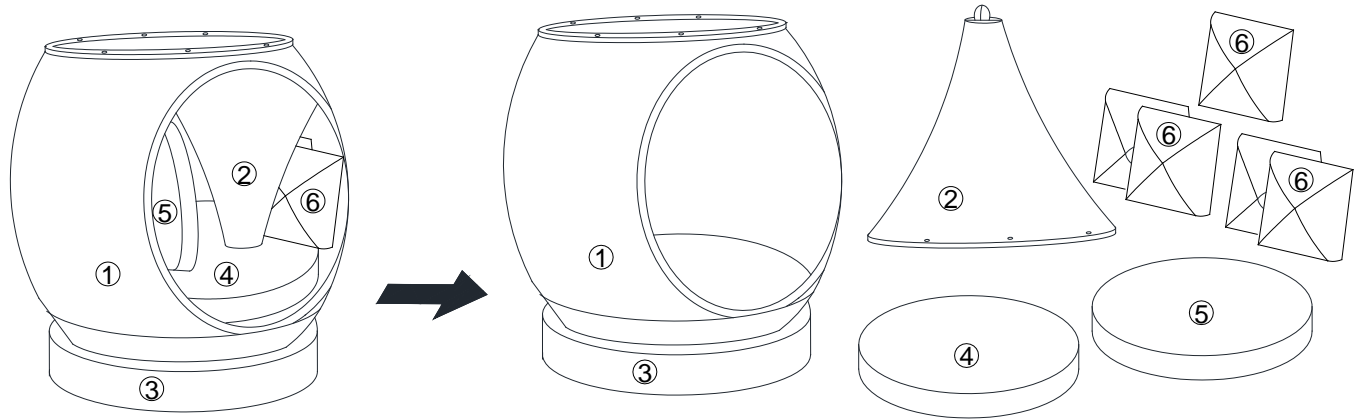

## STEP 2:

Attach **Bed Top (2)** to the top of **Bed Body (1)**, please make sure the holes are aligned.

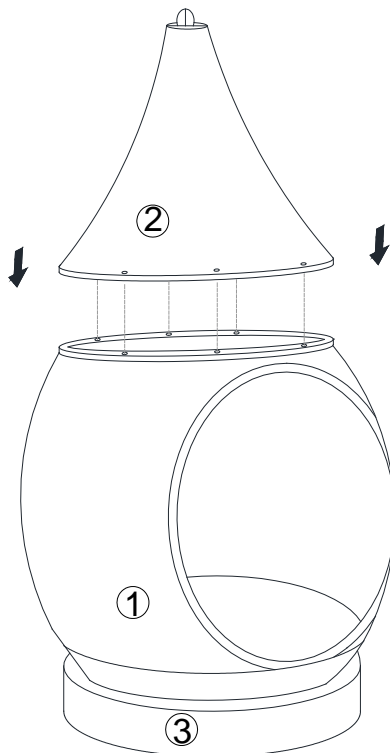

# EEI-2302 ROUND BED

## STEP 3:

**Note:** Bolt (A) will be connects the Bed Top (2) to the Bed Body (1). 6 pieces Nut (C) needs to be locked from inside the basket.

Insert 6 pieces Bolt (A) with 6 pieces Flat Washers (B) into the top holes on the Bed Top (2) as picture, Then insert 6 pieces Flat Washers (B) and 6 pieces Nut (C) onto the Bolts (A) & tighten Bolts (A) by using Allen Wrench (G) and Wrench (E) as shown.

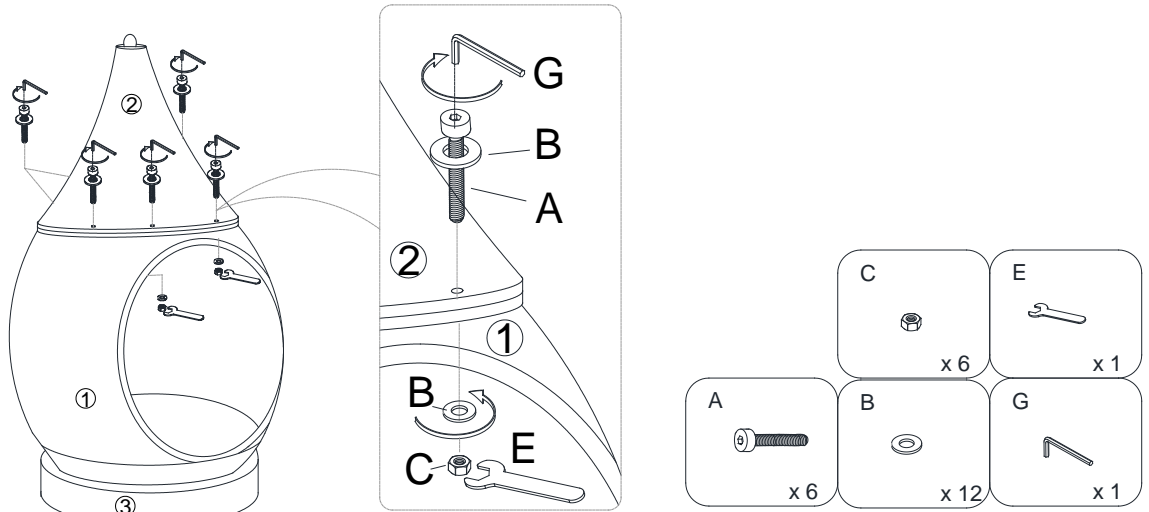

Hardware & Tools required

## STEP 4:

Just put the assembled round bed on the flat surface.

Put Bed Cushion (4) and 5 pieces Pillow (6) to the assembly unit as shown. And cover the head of Nut (C) with 6 pieces Cover (D). Just put the assembled round bed on the flat surface.

The option 1 assembly is complete. Your round bed is ready to be used now!

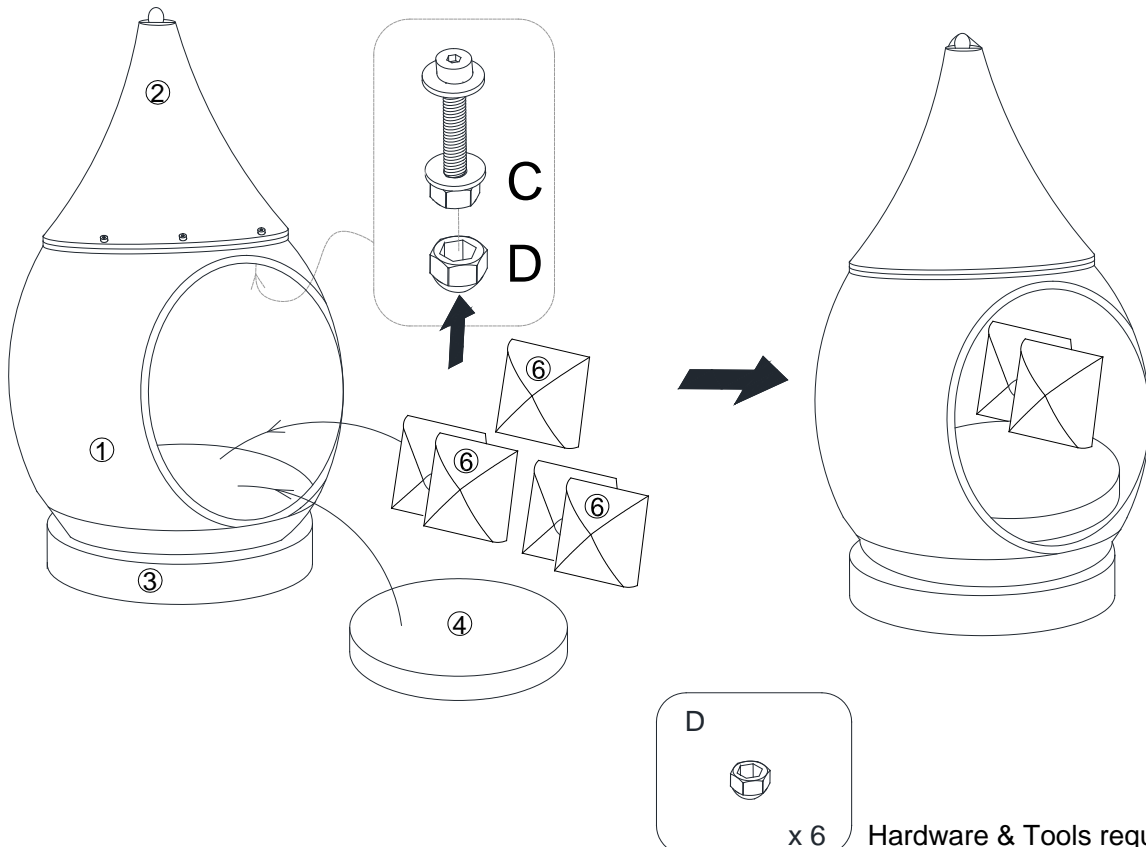

Hardware & Tools required

# EEI-2302 ROUND BED

## STEP 5:

And also you can hang the assembled round bed into anywhere you want to hang.

Please follow the arrow to pass the **rope (1)** across the top of **Bed Top (2)** and as shown

Remind: make sure the cord is securely attached if the round bed is hoisted, the round bed maximum load is 250kg. The **option 2** assembly is complete.

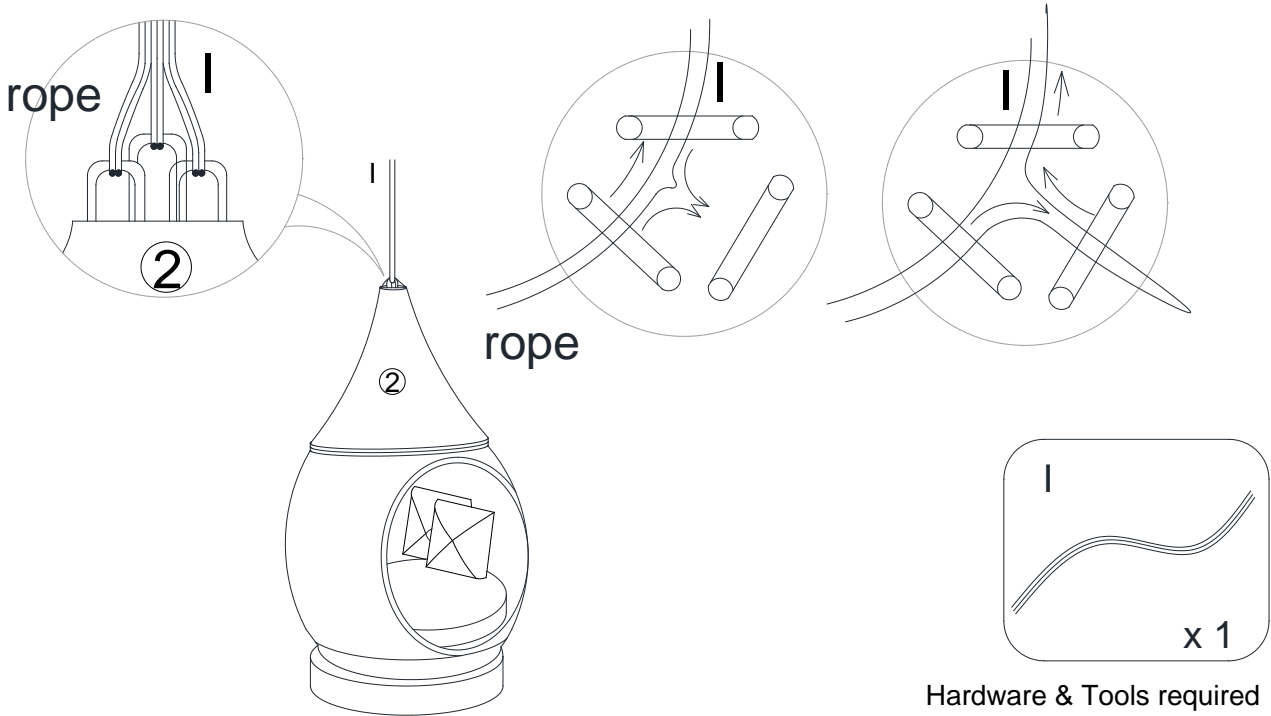

## STEP 6:

And also you can be taken out of the bottom foot and used as ottoman, please follow below step.

Then take out bolts from the bottom of **Bed Foot (3)** by using **Allen Wrench (F)** as shown. Please do not throw away the unloaded bolts.

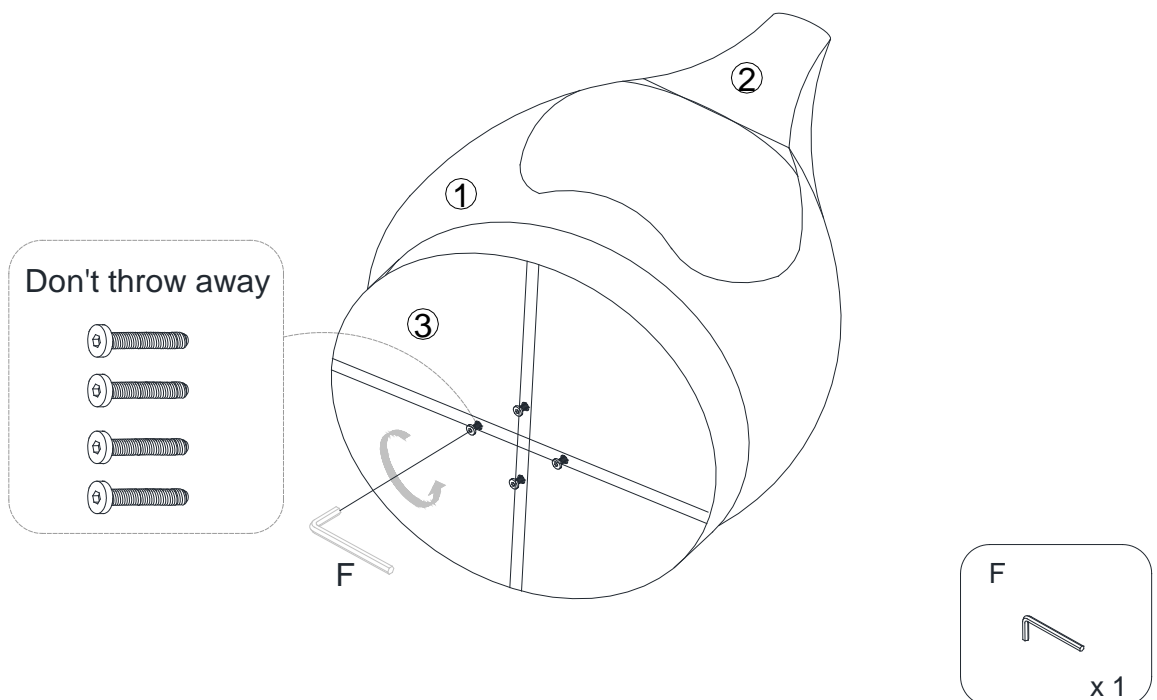

# EEI-2302 ROUND BED

## STEP 7:

Insert 8 pieces **Support Foot (H)** into the bottom holes of **Bed Body (1)** , Tighten **Support Foot (H)** by hand.

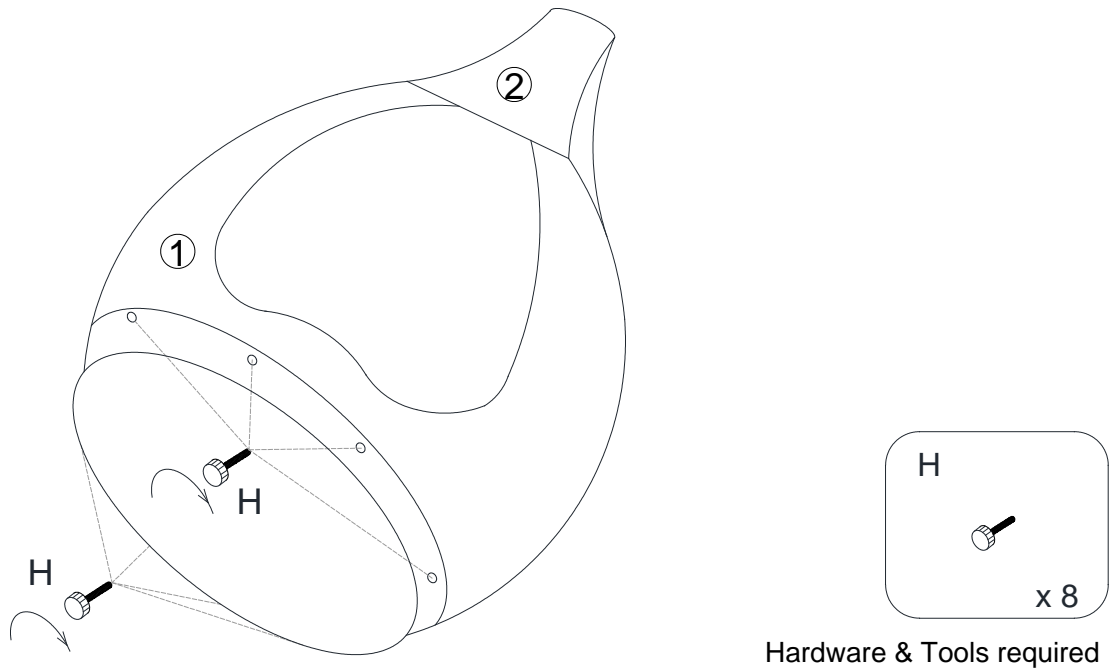

Hardware & Tools required

## STEP 8:

Put **Bed Cushion (4)** and **Ottoman Cushion (4)** and 5 pieces **Pillow (6)** to the assembly unit & **Bed Foot (3)** as shown. The **option 3** assembly is complete, now your round bed is ready to be used now!

