



Thank you for purchasing the **MODWAY CASUAL CHAIR!**

Before you start, here is some helpful advice:

1. We suggest you spend a short time reading through this leaflet and then follow the simple step by step instructions.
2. Owing to the size and weight of the bench, we recommend that it is assembled by two adults, on a carpeted or padded area, in the room that it is intended for. Approx assembly time: 30 minutes.
3. Please do not use any tools other than those provided or recommended in these instructions.
4. Please do not throw away any of the packaging or the instruction until you have checked all the components and hardware and the furniture is fully assembled. Please ensure that the packaging is disposed of in a safe environmentally friendly way.
5. Assemble all components loosely until advised to tighten. Depending on use, it may be necessary to tighten the components from time to time, so please save the tools that has been provided.
6. Please keep all fitting out of reach of children.



Hardware:

- | | | | |
|---|--|-----------------|----|
| A |  | Bolt M6x25mm | x4 |
| B |  | Allen Wrench M4 | x1 |

Component:

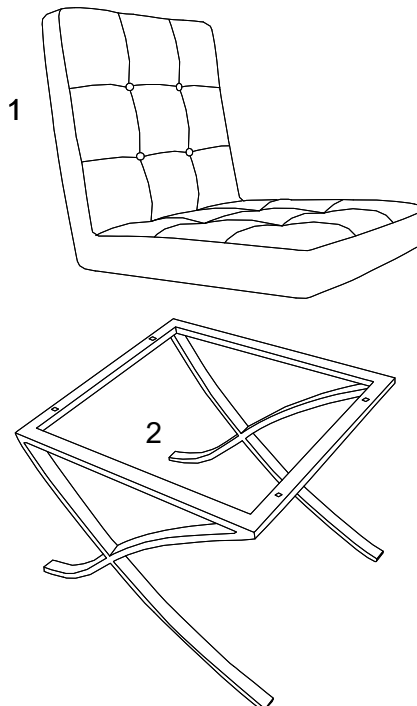



STEP 1:

Please put **Chair Body (1)** upside down on a carpeted or padded area.

Attach **Chair Base (2)** into the holes of the bottom of **Chair Body (1)** by using 4 pieces of **Bolt (A)** as shown.

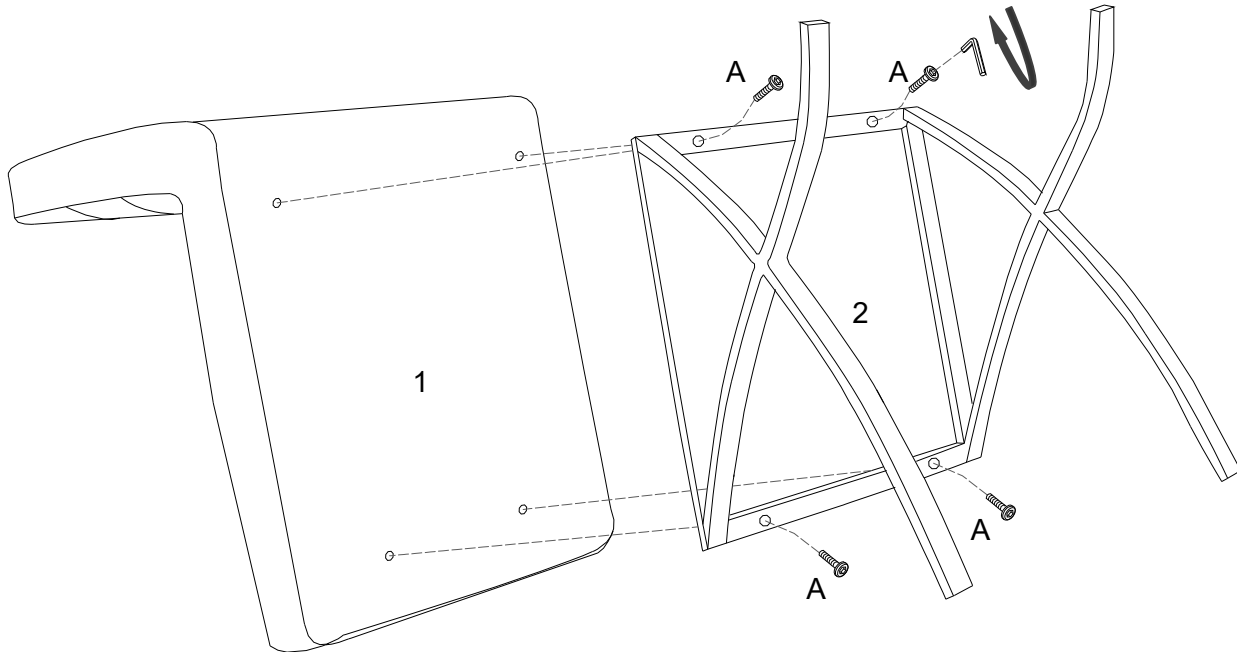
Use **Allen Wrench (B)** to tighten all **Bolts (A)** clockwise until secure.



	
Ax4	Cx1

Hardware & Tool required

STEP 2:

Carefully turn over the assembled chair.

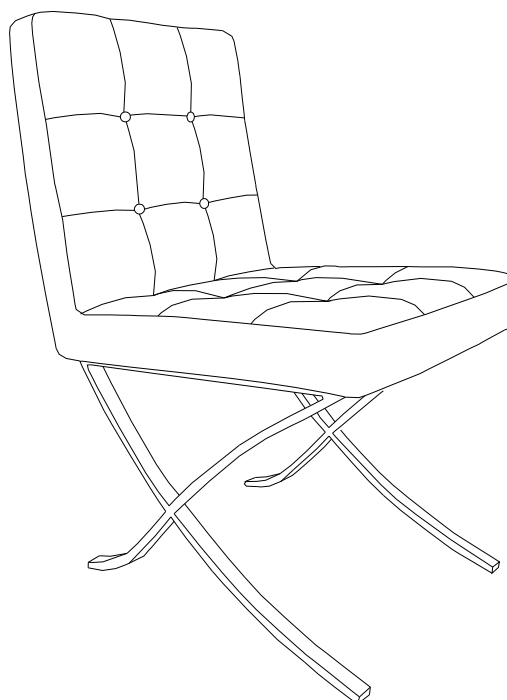

Assembly is completed. The chair is ready to enjoy now!